

SECTION VIEW

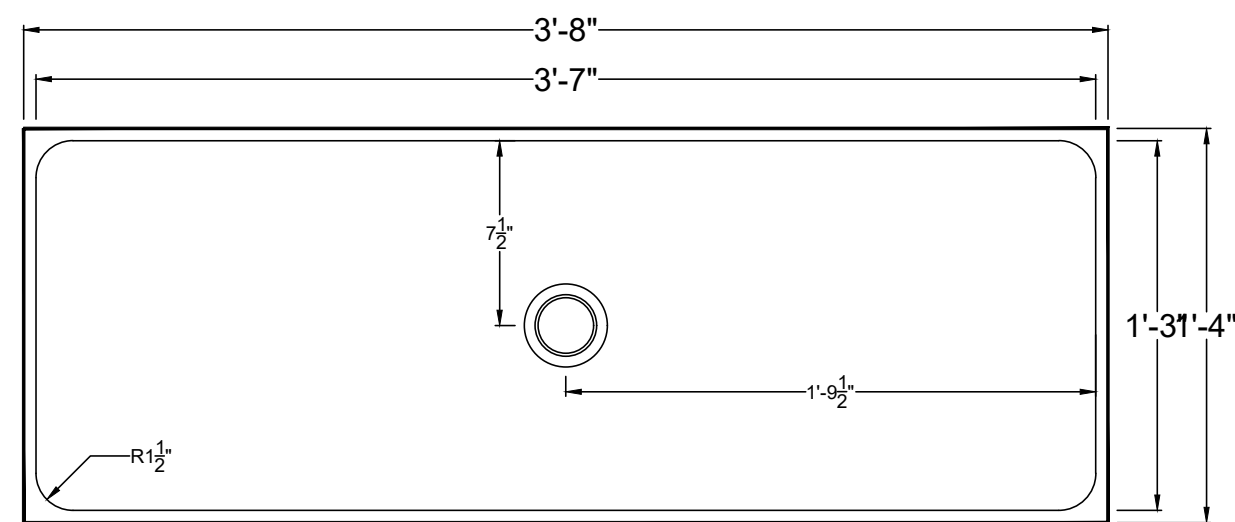

TOP VIEW

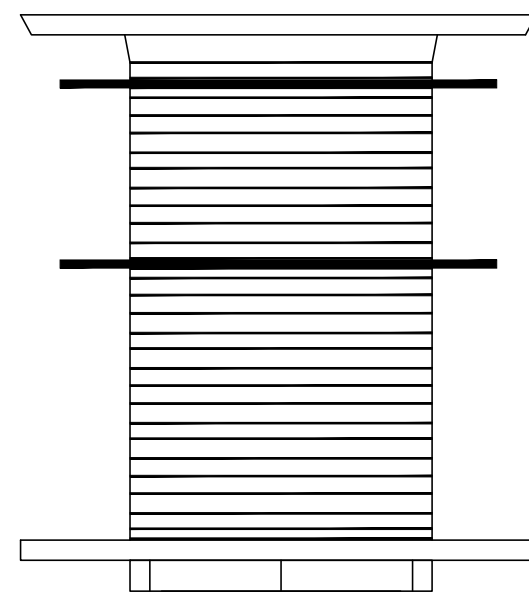
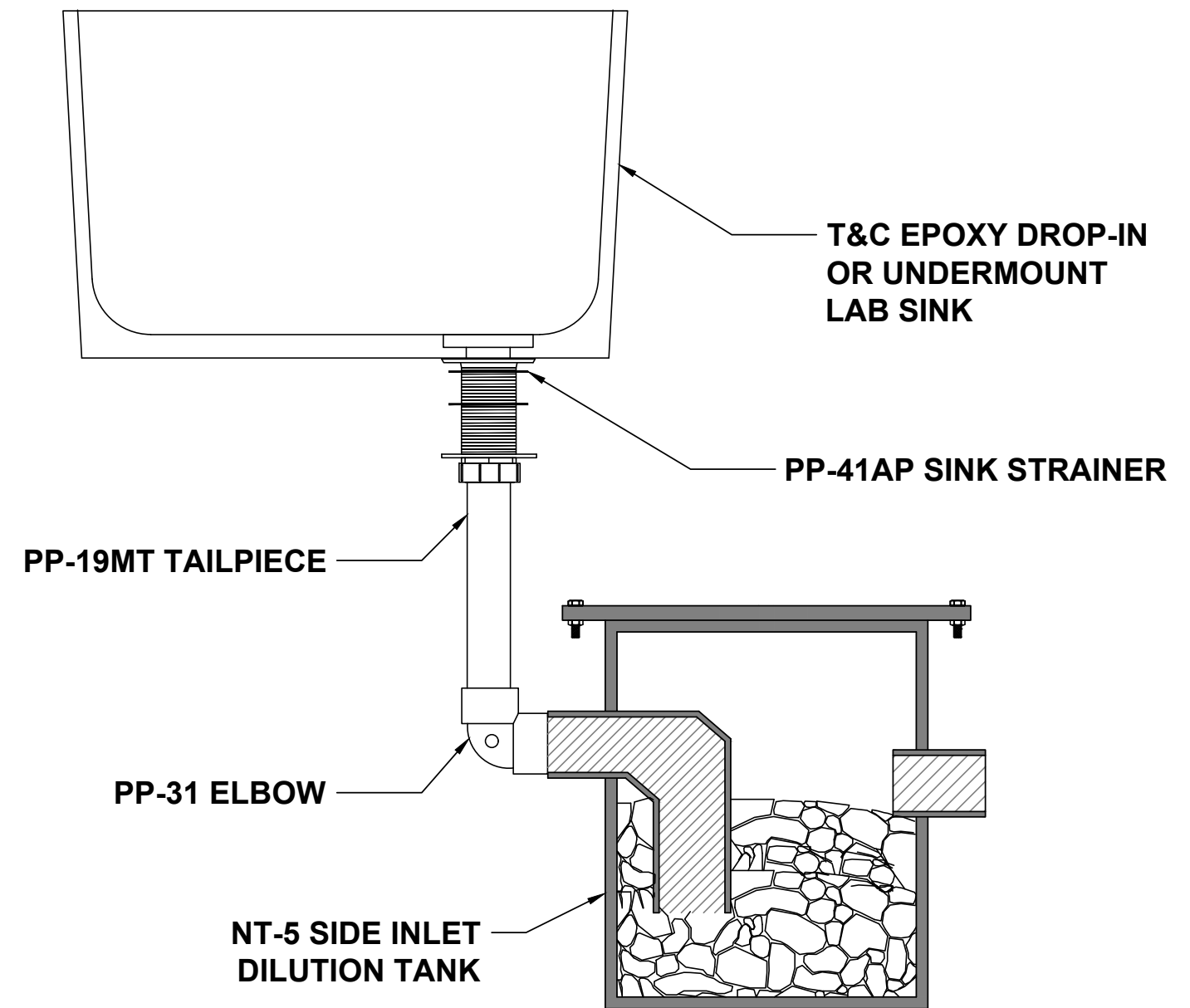

PP-41AP

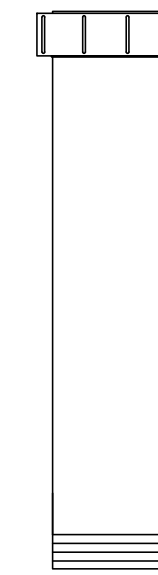

PP-19MT

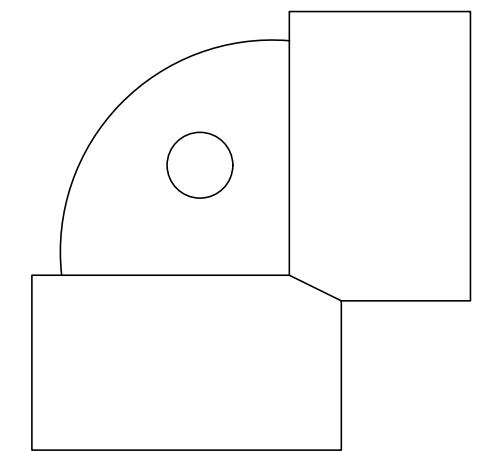

PP-31

NOTES:

UNLESS STATED OTHERWISE DIMENSIONS ARE IN INCHES	MATERIAL:		
	WEIGHT [lb]:	NAME	DATE
	DO NOT SCALE DRAWING	CHECKED	03/01/2023

TITLE: UNDERMOUNT SINK

U71C	REV:
SHEET 1 OF 1	SIZE:
SCALE: N/A	

T&C PLASTICS
 WWW.TANDCPLASTICS.COM
 732-780-5300

THE INFORMATION CONTAINED IN THIS DRAWING IS THE SOLE PROPERTY OF TOWN & COUNTRY PLASTICS LLC. ANY REPRODUCTION IN PART OR AS A WHOLE WITHOUT THE WRITTEN PERMISSION OF TOWN & PLASTICS LLC IS PROHIBITED.