

SECTION VIEW

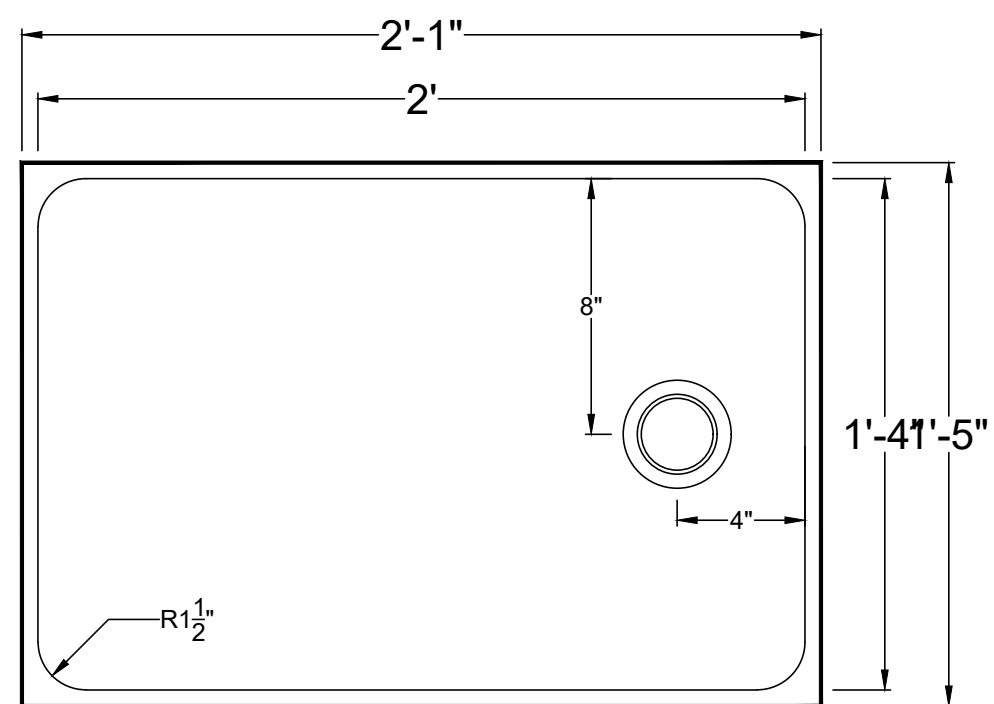

TOP VIEW

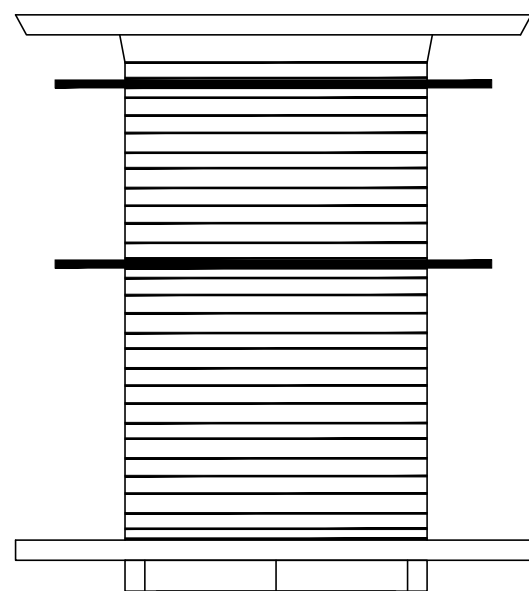
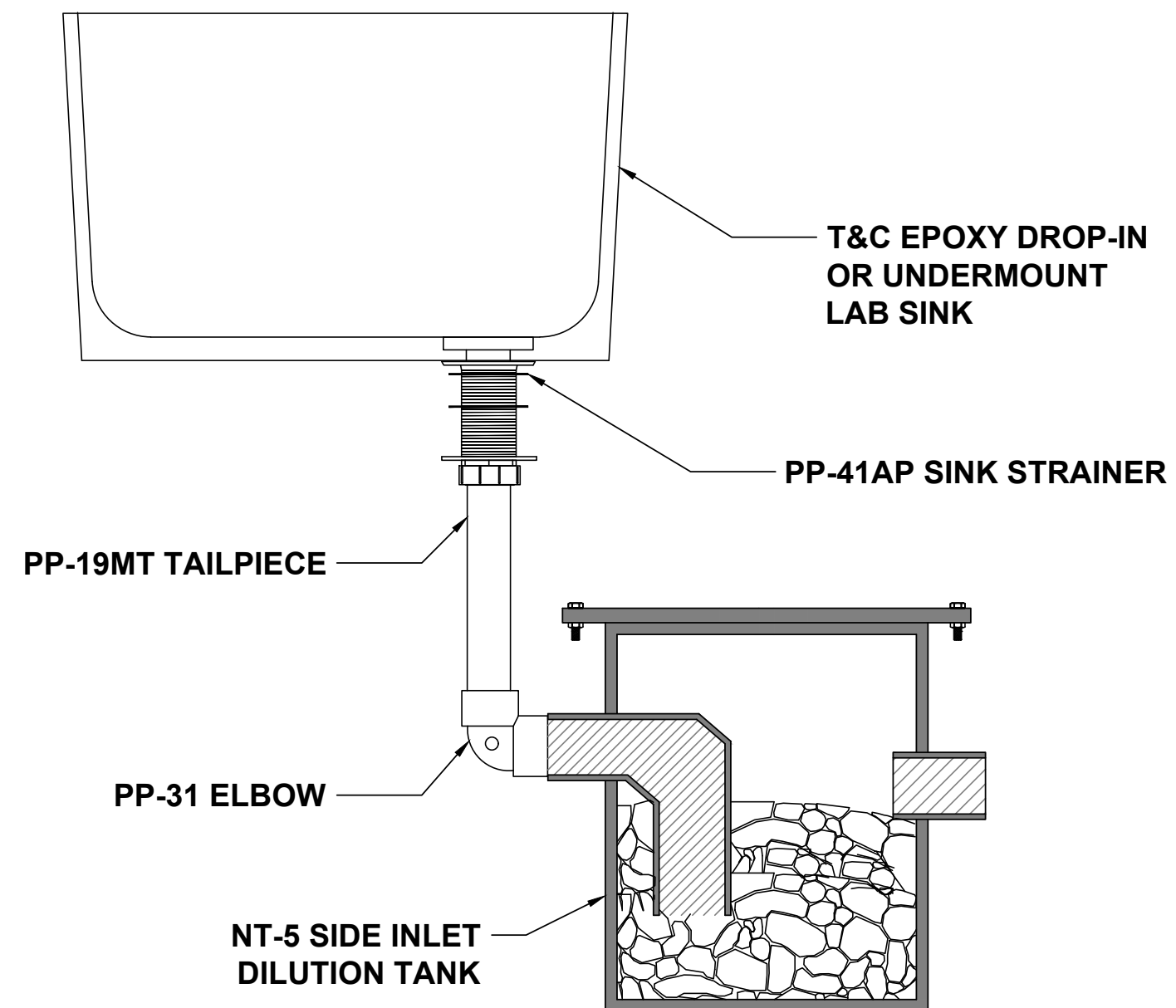

PP-41AP

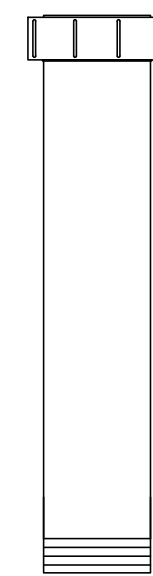

PP-19MT

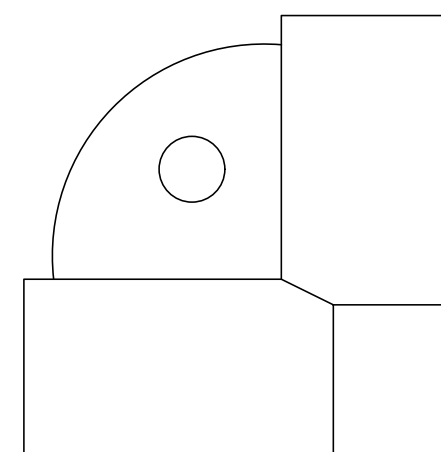

PP-31

NOTES:

UNLESS STATED OTHERWISE DIMENSIONS ARE IN INCHES

DO NOT SCALE DRAWING

MATERIAL:			
WEIGHT [lb]:		NAME	DATE
		DRAWN DR	03/01/2023
DO NOT SCALE DRAWING		CHECKED	

TITLE:

UNDERMOUNT SINK

U50C

SHEET 1 OF 1

SCALE: N/A

REV:

SIZE:

T&C PLASTICS

WWW.TANDCPLASTICS.COM

732-780-5300

THE INFORMATION CONTAINED IN THIS DRAWING IS THE SOLE PROPERTY OF TOWN & COUNTRY PLASTICS LLC. ANY REPRODUCTION IN PART OR AS A WHOLE WITHOUT THE WRITTEN PERMISSION OF TOWN & PLASTICS LLC IS PROHIBITED.