

SECTION VIEW

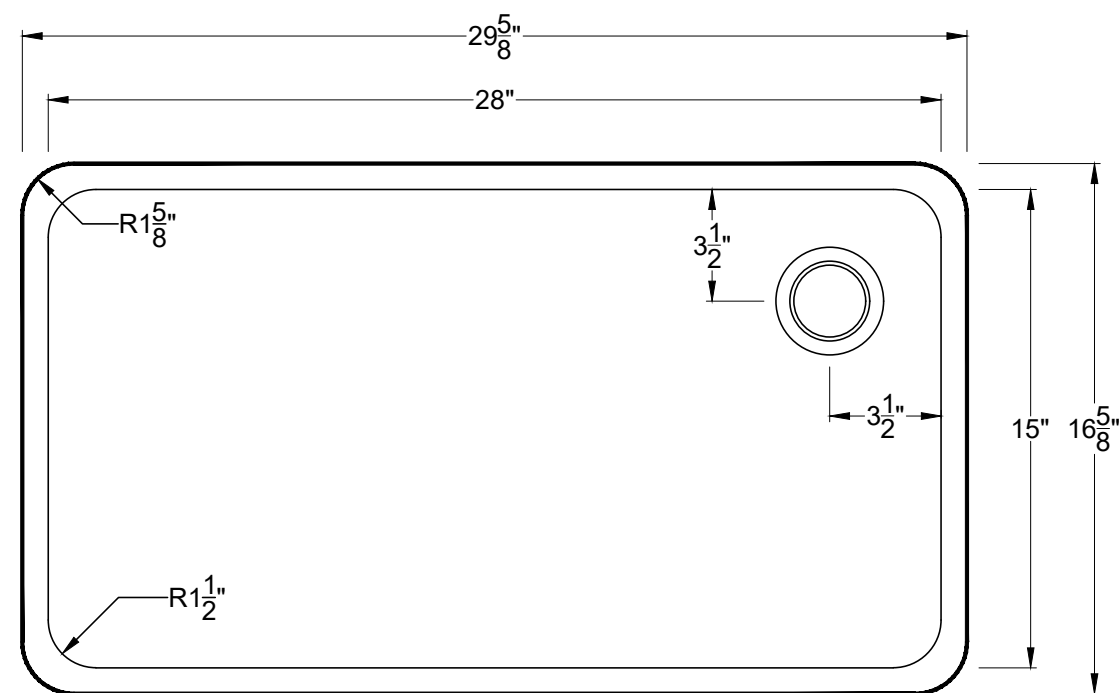

TOP VIEW

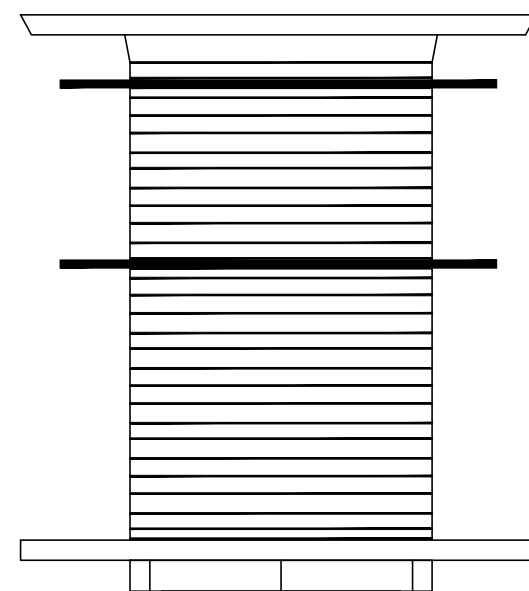
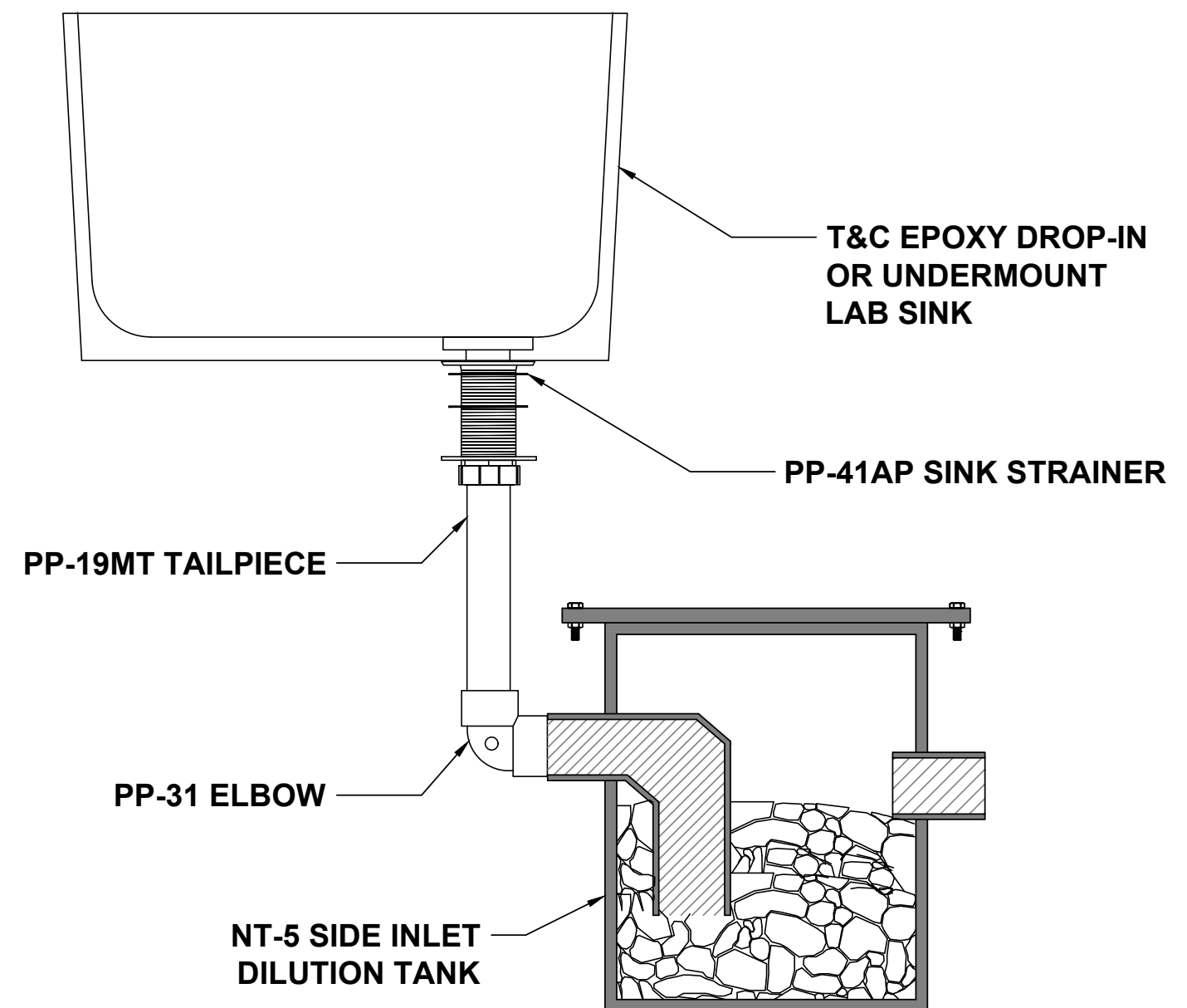

PP-41AP

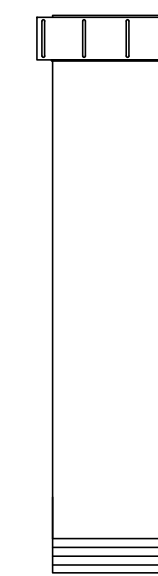

PP-19MT

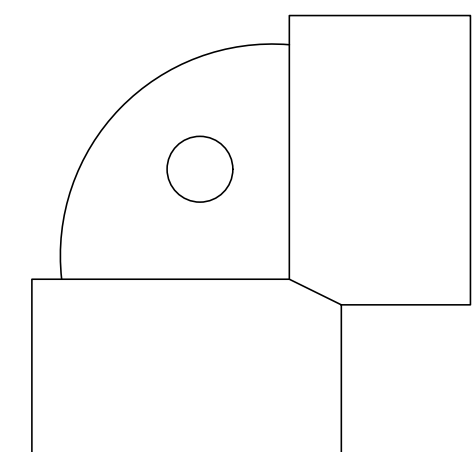

PP-31

NOTES:

UNLESS STATED OTHERWISE DIMENSIONS ARE IN INCHES	MATERIAL:			
	WEIGHT [lb]:		NAME	DATE
	DO NOT SCALE DRAWING		CHECKED	03/01/2023

TITLE: **DROP IN SINKS**

D-59
SHEET 1 OF 1
SCALE: N/A

REV:
SIZE:



THE INFORMATION CONTAINED IN THIS DRAWING IS THE SOLE PROPERTY OF TOWN & COUNTRY PLASTICS LLC. ANY REPRODUCTION IN PART OR AS A WHOLE WITHOUT THE WRITTEN PERMISSION OF TOWN & PLASTICS LLC IS PROHIBITED.