

**SECTION VIEW**

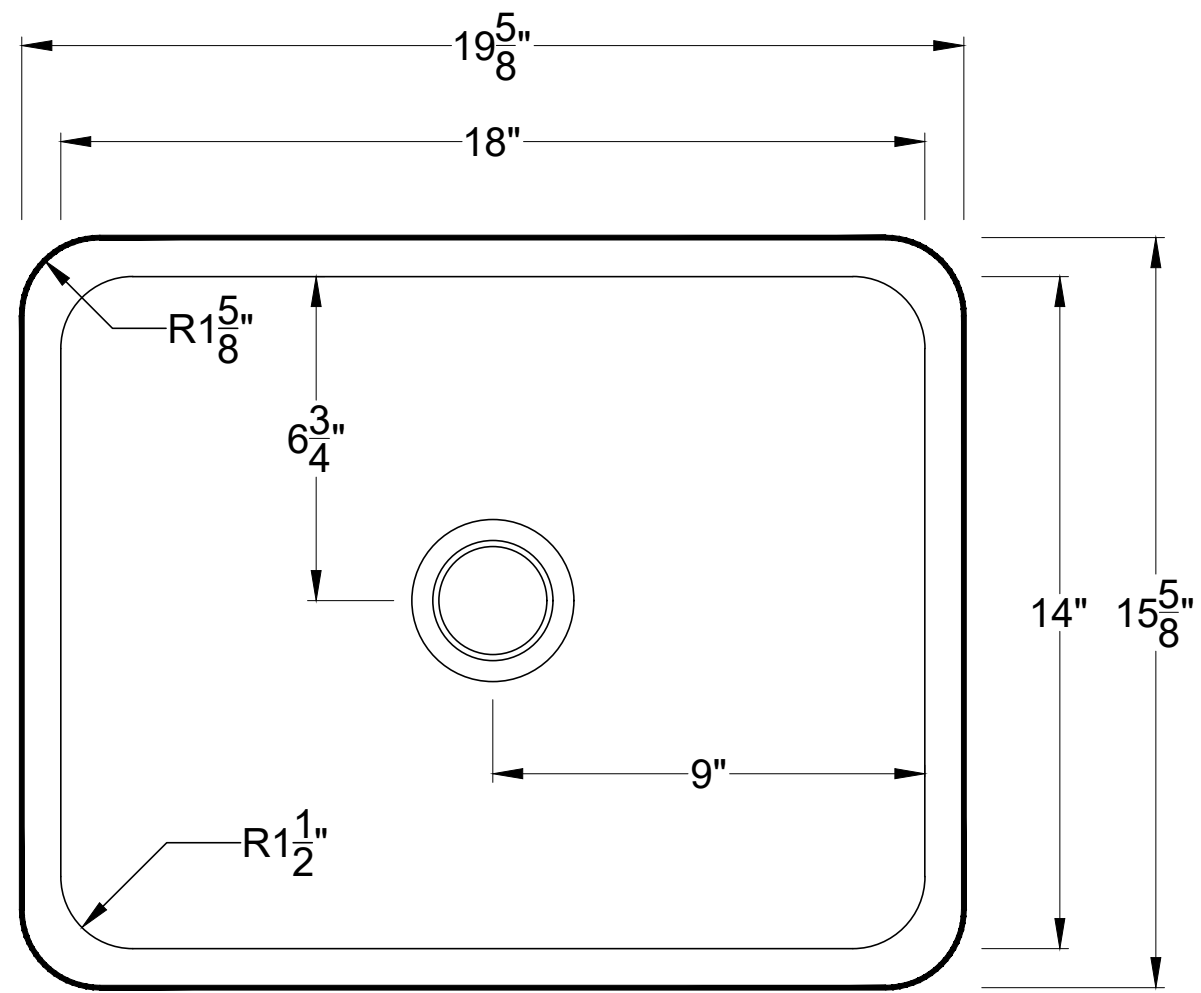

**TOP VIEW**

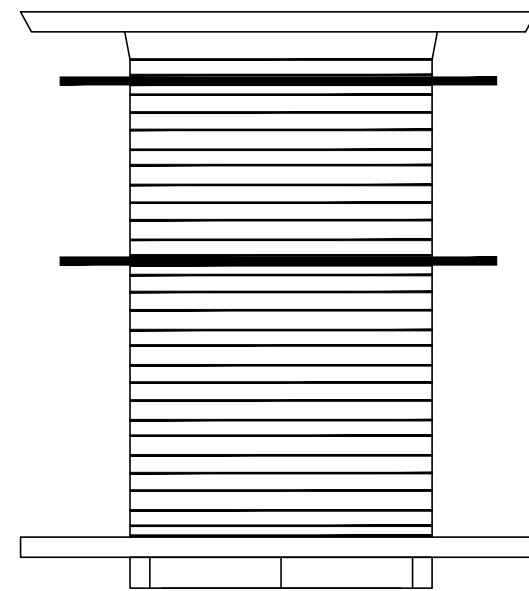
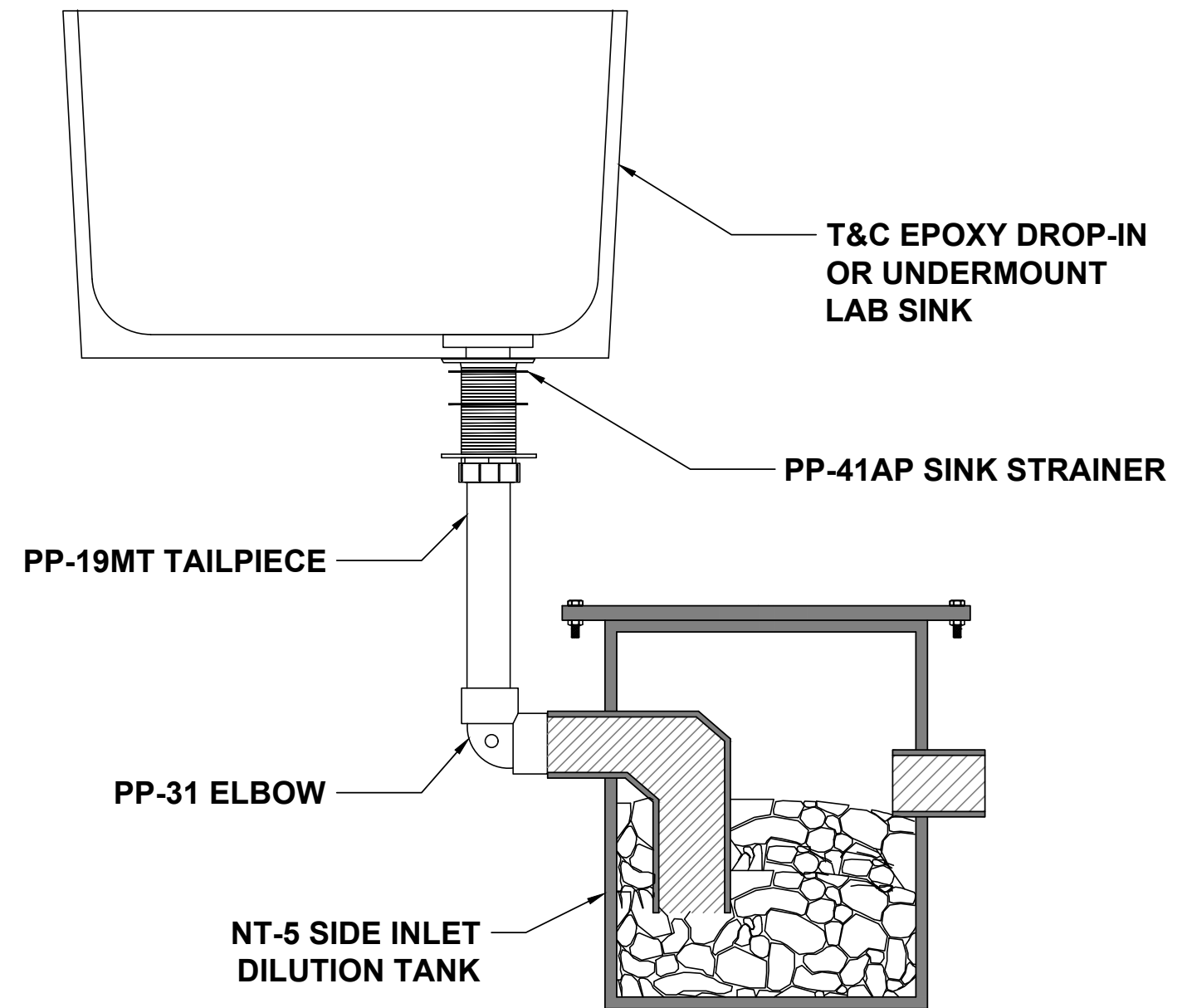

**PP-41AP**

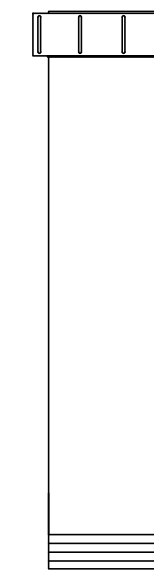

**PP-19MT**

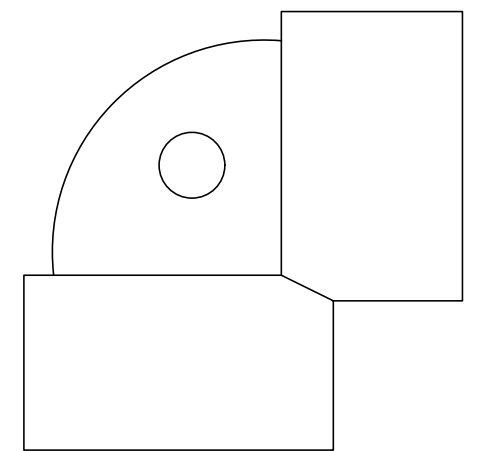

**PP-31**

NOTES:

UNLESS STATED OTHERWISE DIMENSIONS ARE IN INCHES	MATERIAL:		
	WEIGHT [lb]:	NAME	DATE
	DO NOT SCALE DRAWING	CHECKED	

TITLE:  
**DROP IN SINKS**

<b>D-24C</b>	REV:
SHEET 1 OF 1	SIZE:
SCALE: N/A	

**T&C PLASTICS**  
WWW.TANDCPLASTICS.COM  
732-780-5300

THE INFORMATION CONTAINED IN THIS DRAWING IS THE SOLE PROPERTY OF TOWN & COUNTRY PLASTICS LLC. ANY REPRODUCTION IN PART OR AS A WHOLE WITHOUT THE WRITTEN PERMISSION OF TOWN & PLASTICS LLC IS PROHIBITED.